

# Rentgenostruktūrinė analizė

Saulius Gražulis  
Palanga 2012 m.

# Kristalai

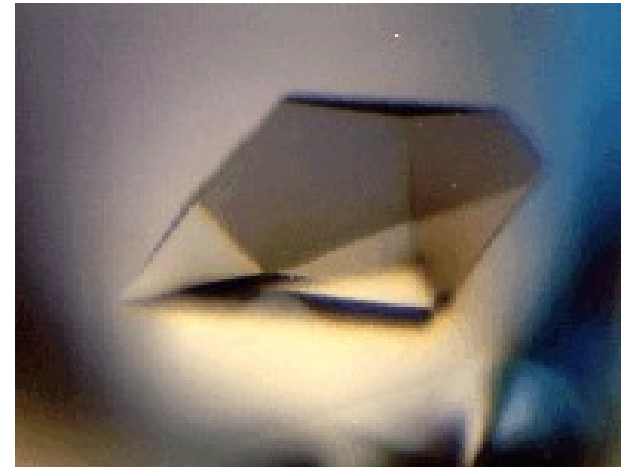

# Kristalo formas paaiškinimas

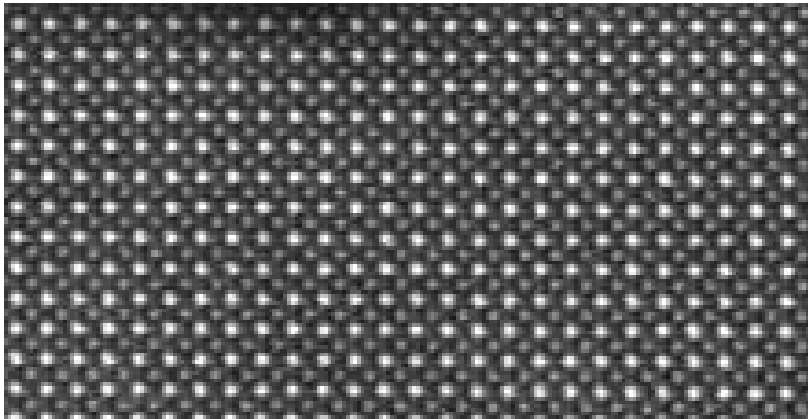

Johannes Kepler  
1611 m. „Strena Seu  
de Nive Sexangula“  
(A New Year's Gift of  
Hexagonal Snow)

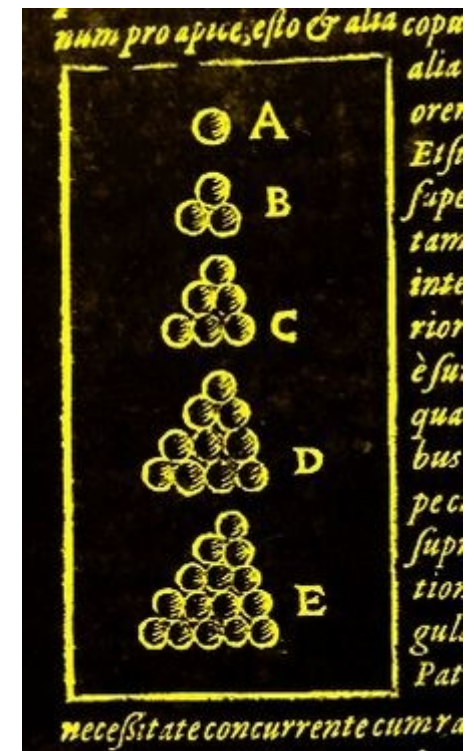
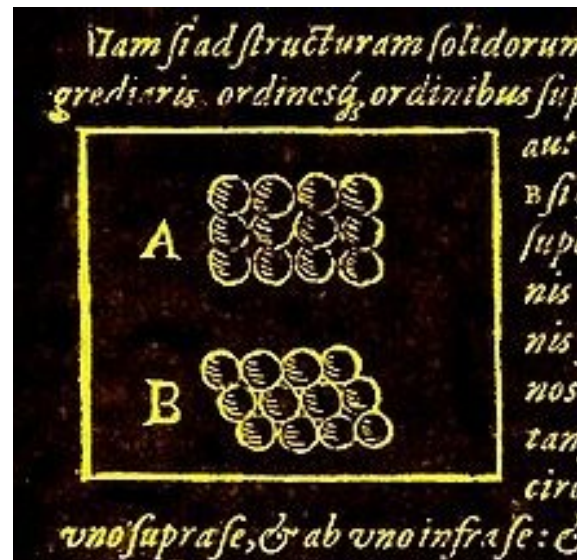

# Kampų pastovumo dėsnis

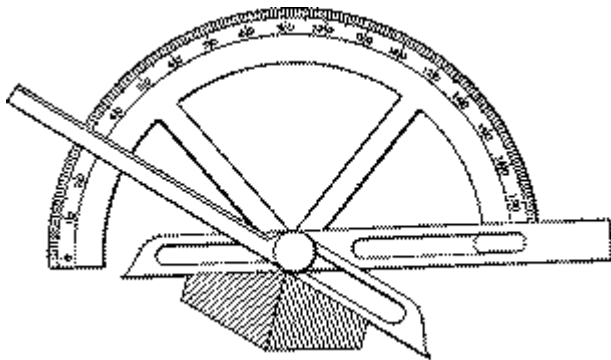
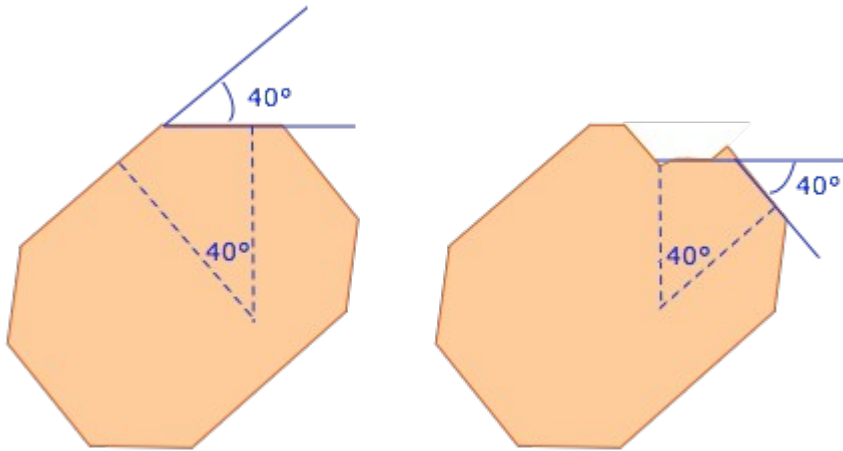

Nicolas Steno

1669 m. „De solido intra solidum  
naturaliter contento“

# Vidinē kristaļu struktūra

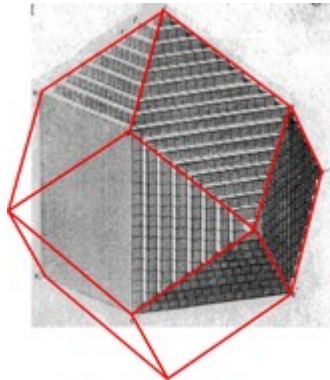

Rhomb-dodecahedron

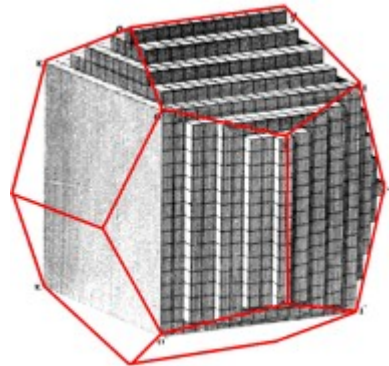

Pentagon-dodecahedron

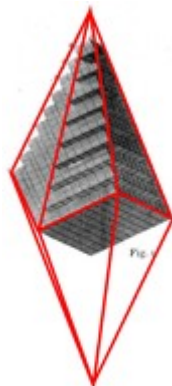

Scalenohedron



René Just Haüy [aɥi]  
Traité de minéralogie  
(5 vols, 1801)

Paveikslėliai iš

<http://xrayweb.chem.ou.edu/notes/symmetry.html>



# Rentgeno spinduliai



Wilhelm Conrad  
Röntgen  
the first Nobel  
Prize in Physics in  
1901

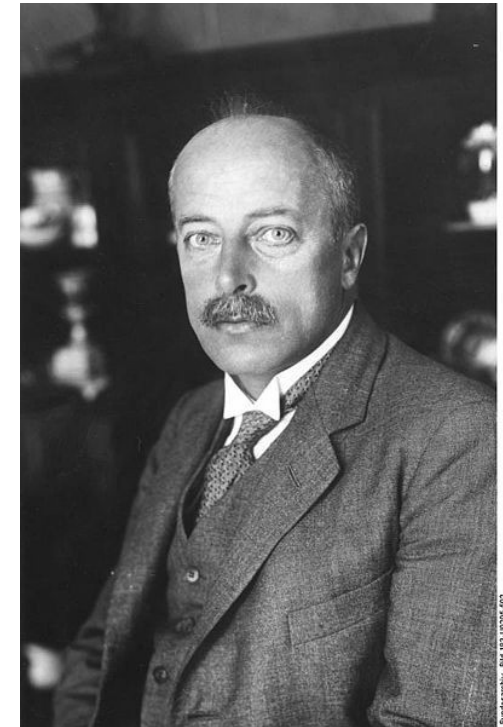
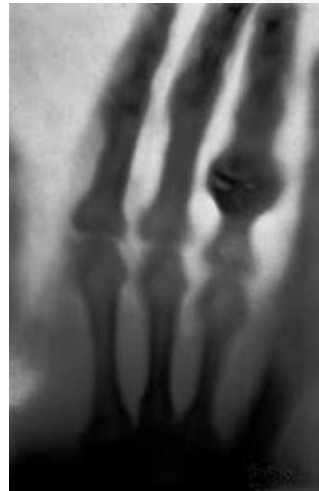
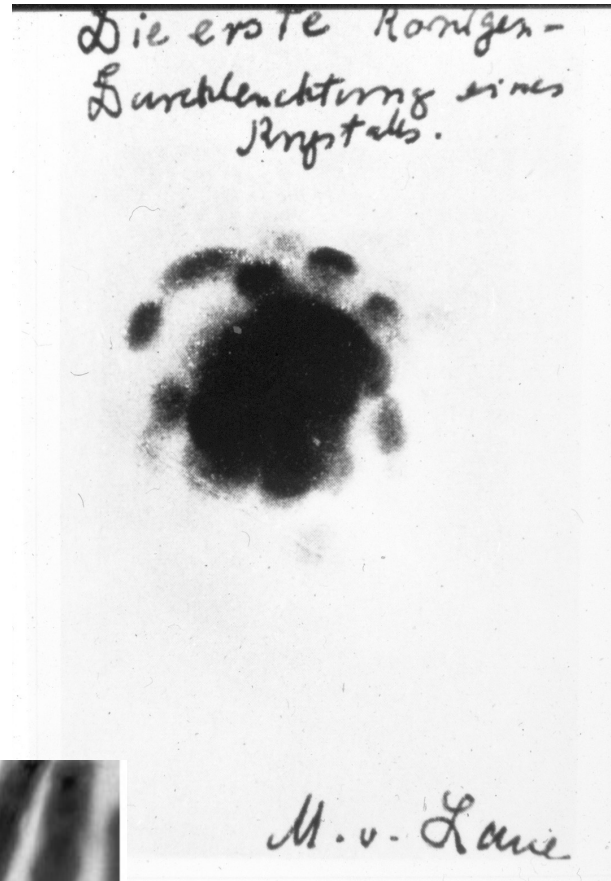

Max von Laue  
Nobel Prize (1914)

# Struktūra - svarbu!

Izomerai turi skirtingas savybes, nors jų sudėtis ta pati:



# Alfa-spiralēs ir beta-klostēs

Alfa-spiralē

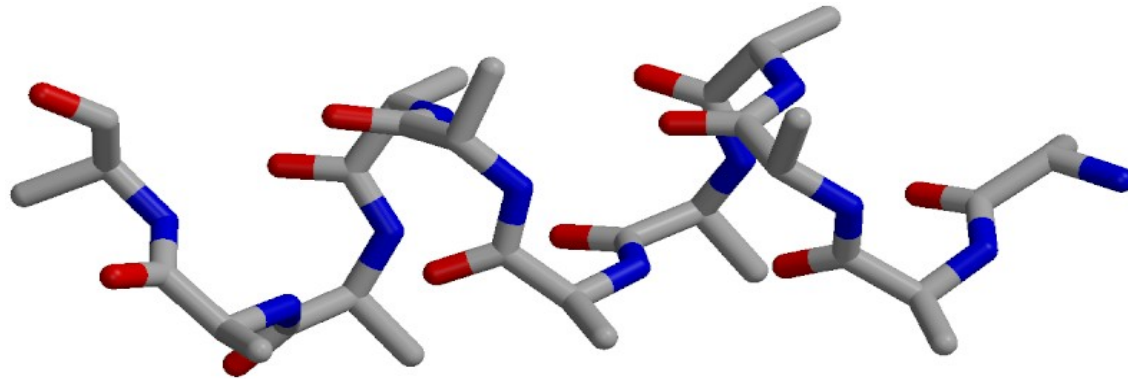

Beta-klostē

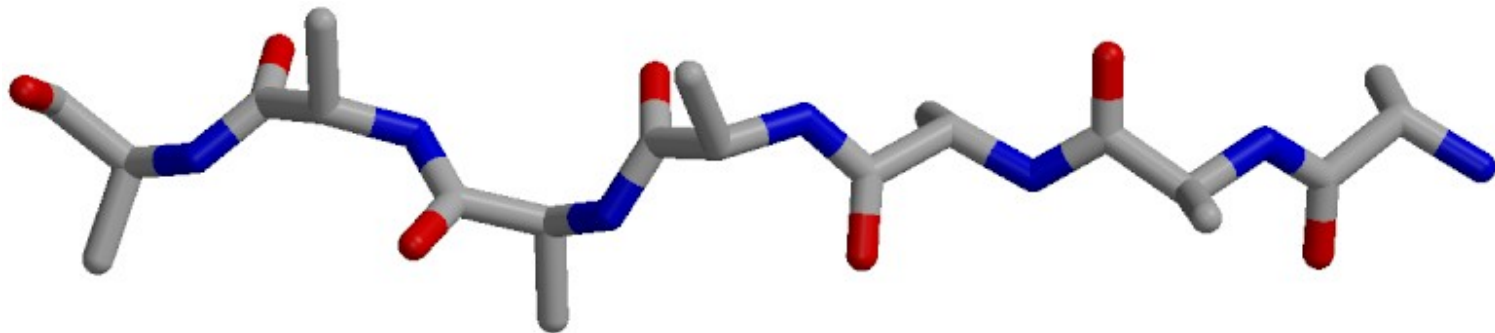



# Bioginēs makromolekulēs yra ilgi polimerai

Tipiška baltymo seka (BfiI Restriktazė):

```
MNFFSLHPNV YATGRPKGLI GMLENVVSN HTPGEGTLYL ISGFSNYNGG  
VRFYETFTEH INQGGRVIAI LGGSTSQRSL SRQVVEELLN RGVEVHIINR  
KRILHAKLYG TSNNLGESLV VSSGNFTGPG MSQNIASLL LDNNTTQSMG  
FSWNDMISEM LNQNWHIHM TNATDASPGW NLLYDERTTN LTLDETERVT  
LIVTLGHADT ARIQAAPGTT AGQGTQYFWL SKDSYDFFP LTI RNRRTGK  
ATYSSLINMN YIDINYTDTQ CRVTFEAENN FDFRLGTGKL RYTGVAKSND  
IAAITRVGDS DYELRIIKQG TPEHSQLDPY AVSFIGNRGK RFGYISNEEF  
GRIIGVTF
```

358 amino rūgštys  
40 kDa

# Pirminė seka apsprendžia erdvinę struktūrą

1. Karbamidai (urea) denatūruoja baltymus:

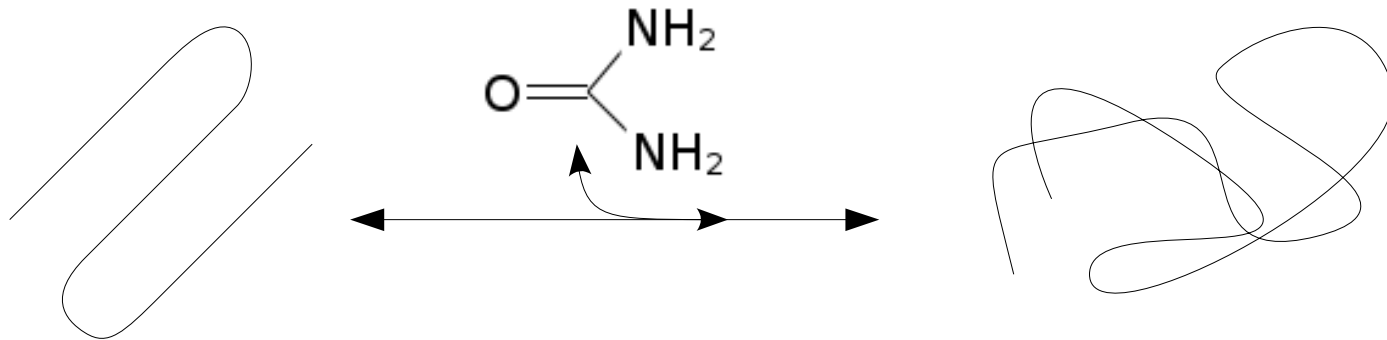

2. Oksidacija sukuria, o redukcija suardo Cys S-S tiltelius:

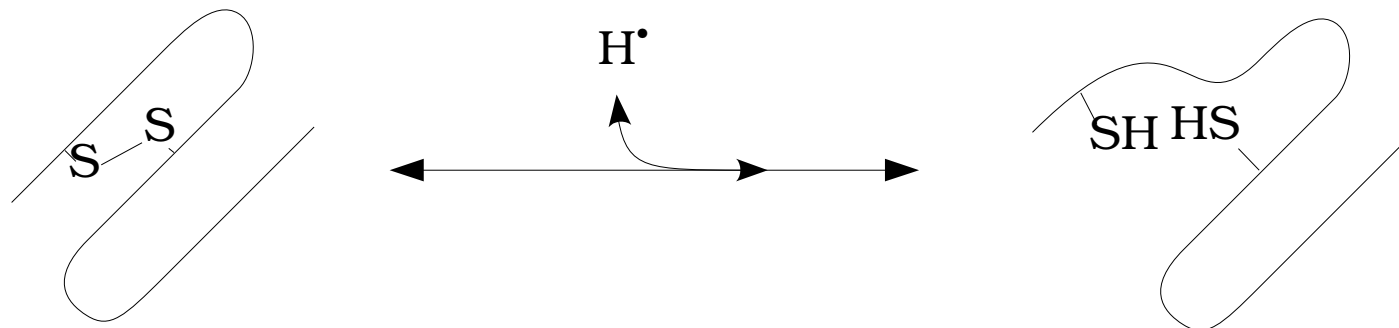

Anson & Mirsky JGP 1931 p.341, Anfinsen PNAS 1961 p.1309

# Baltymo sekos ir struktūros sąryšis

KETAAAKFERQHMDSSSTAASSSNYCNQMMKSRNLTKDRCKPVNTFVHE  
SLADVQAVCSQKNVACKNGQTNCYQSYSTMSITDCRETGSSKYPNCAYKT  
TQANKHIIVACEGNPYVPVHFDASV

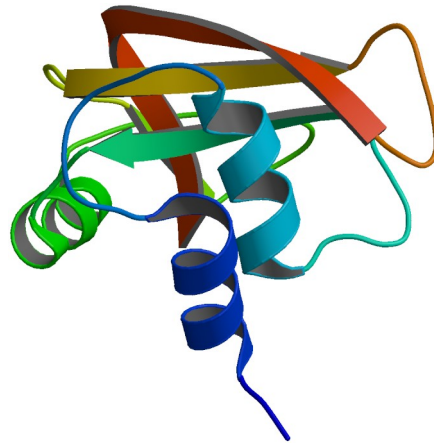
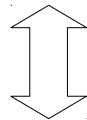

Išvada: baltymo struktūrą ir funkciją iš esmės  
apsprendžia jo a.r. seka.

# Levintalio (Levinthal) paradoksas

Baltymo grandinės galimų konformacijų skaičius:  
100 a.r.,  $\sim 2^{100}$  galimų konformacijų; joms išsamiai  
perrinkti reikėtų:

jei patikrinama 1 konformacija per 1 ps,

$\pi$  s = 1 nano-amžius. ( $3.14$  s =  $10^{-7}$  metų)

$2^{100}$  ps  $\approx 10^{30}$  ps  $\sim \mathbf{10^{10}}$  metų.

Nei realus baltymas, nei kompiuteris visų  
konformacijų perrinkti negali.

# Rentgenostruktūrinē analizē

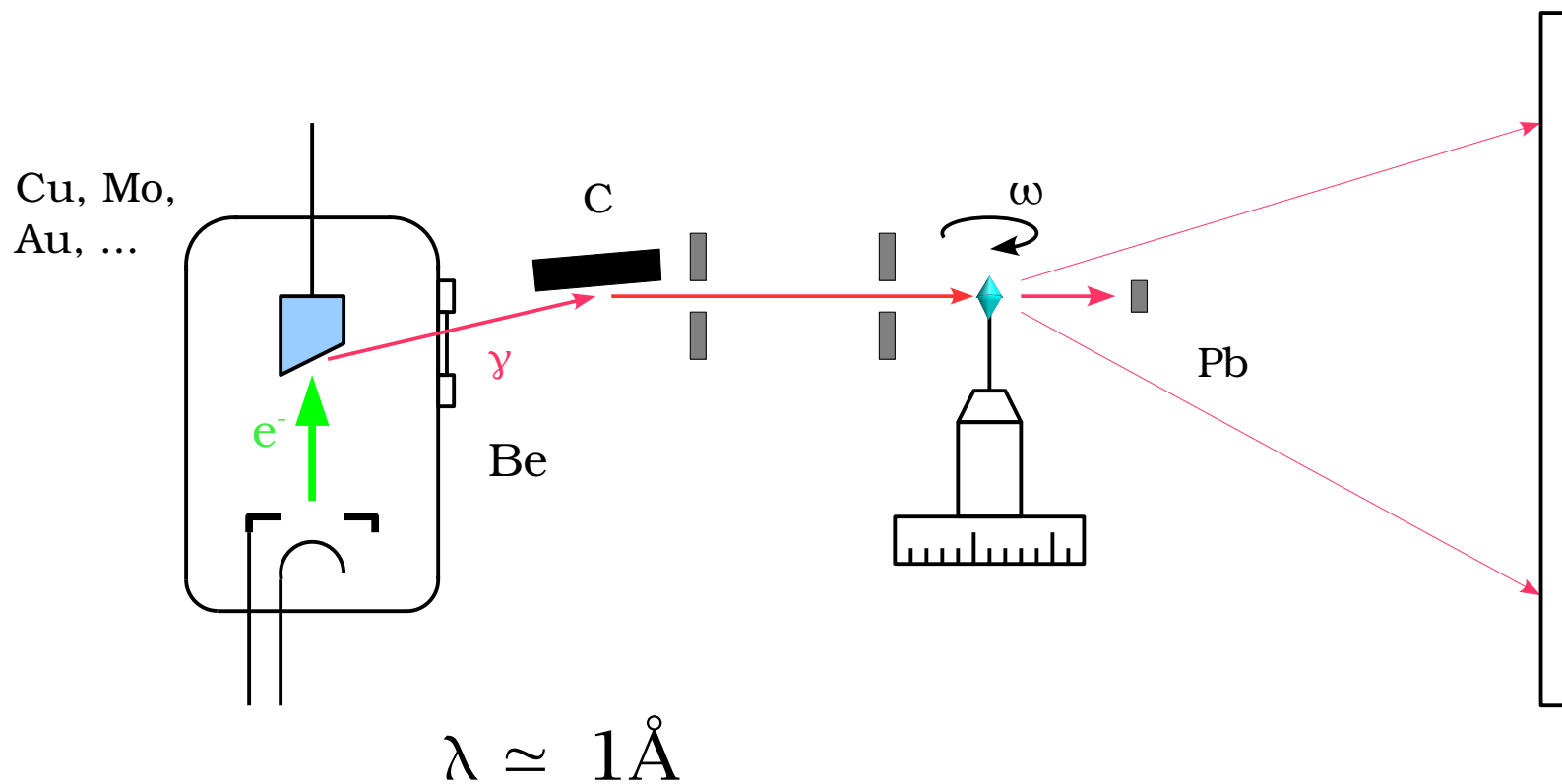

# Rentgeno spindulių šaltiniai

Rentgeno vamzdeliai

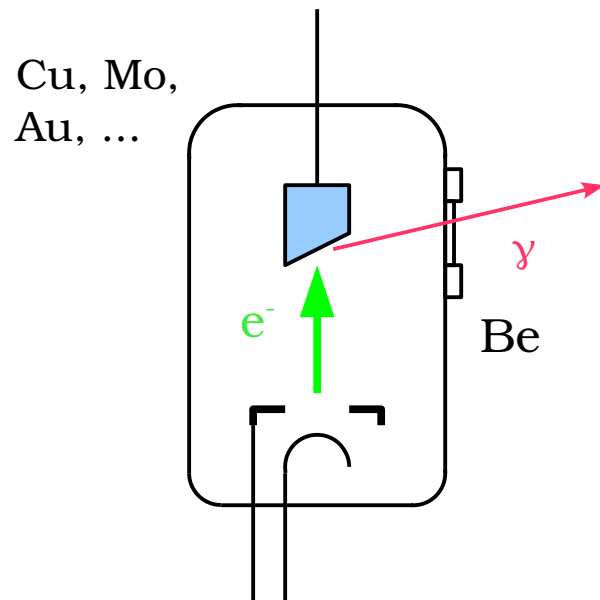

Sinchrononai

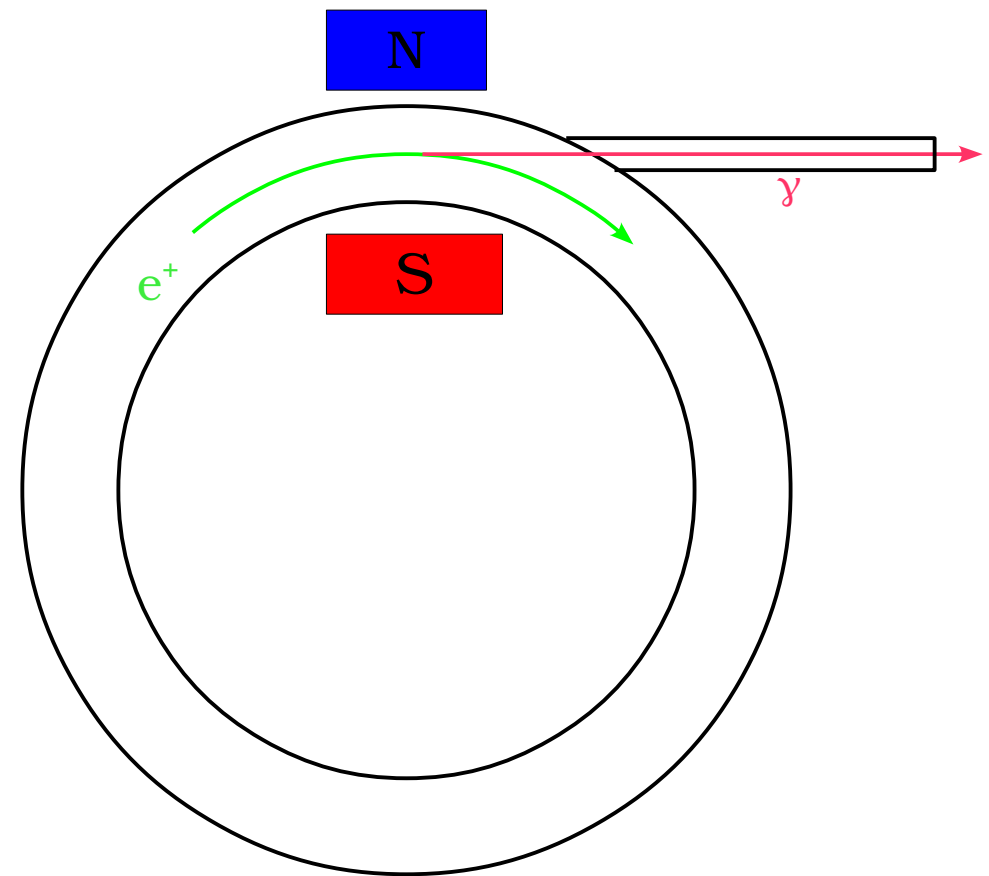



# DNR pluoštų difrakcija

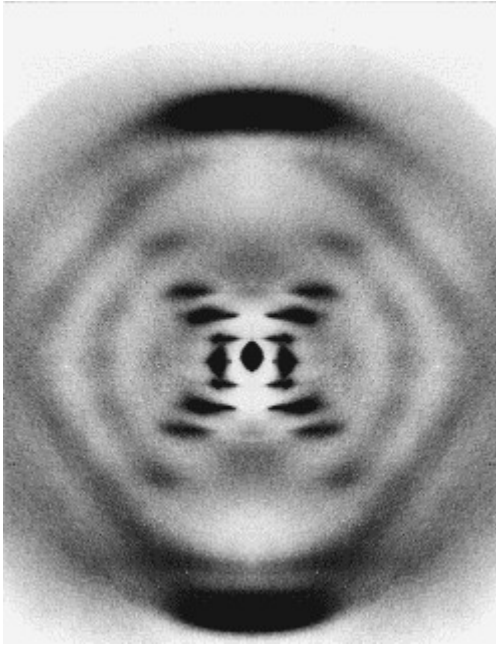

B formos  
rentgenograma

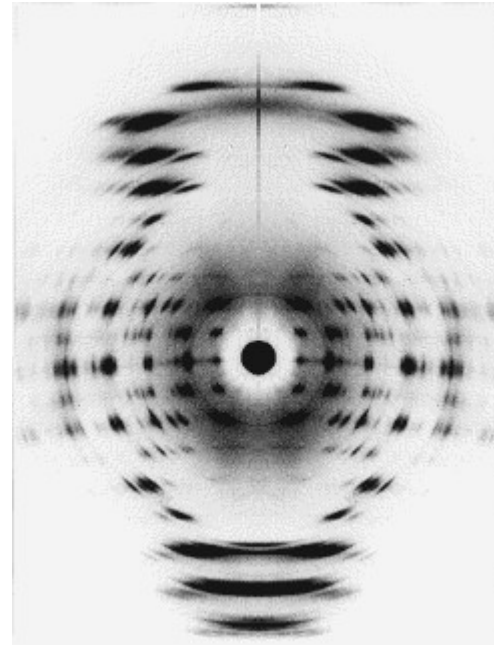

A formos  
rentgenograma

# Watson'o ir Crick'o struktūra

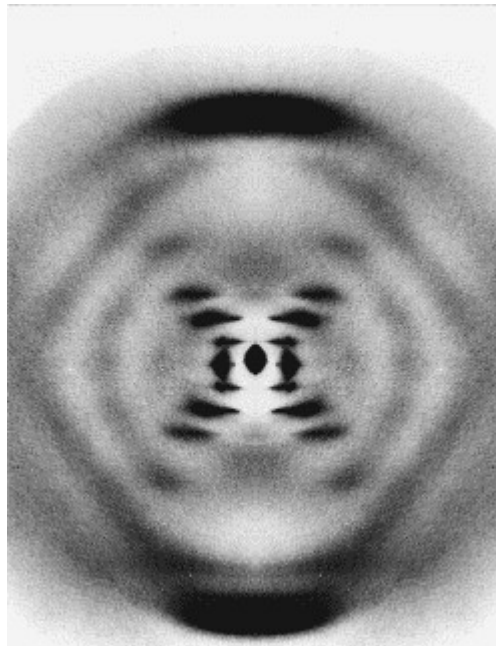

This figure is purely diagrammatic. The two ribbons symbolize the two phosphate—sugar chains, and the horizontal rods the pairs of bases holding the chains together. The vertical line marks the fibre axis

# Baltymų ir DNR kristalai

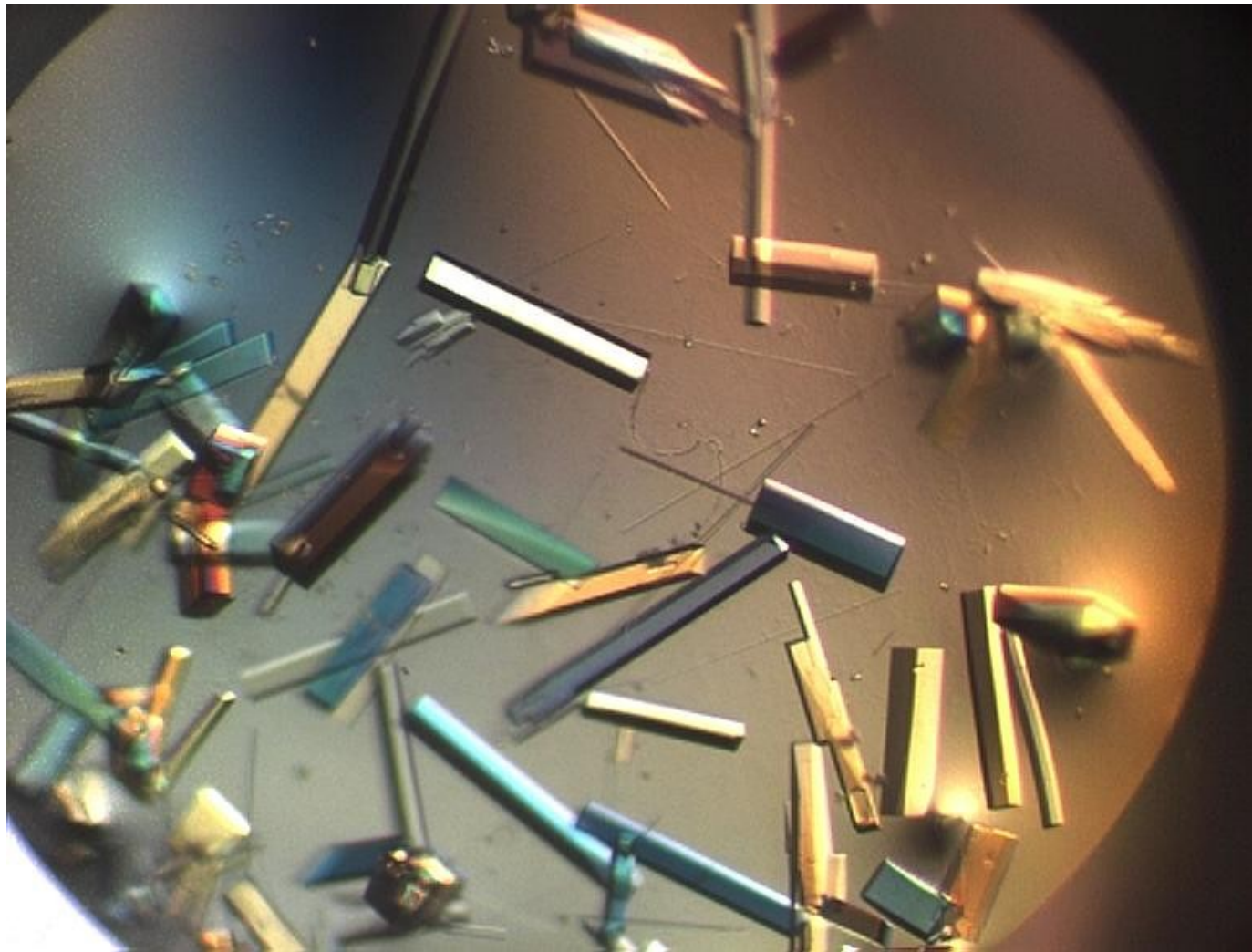

# Krisaļu vidinė struktūra

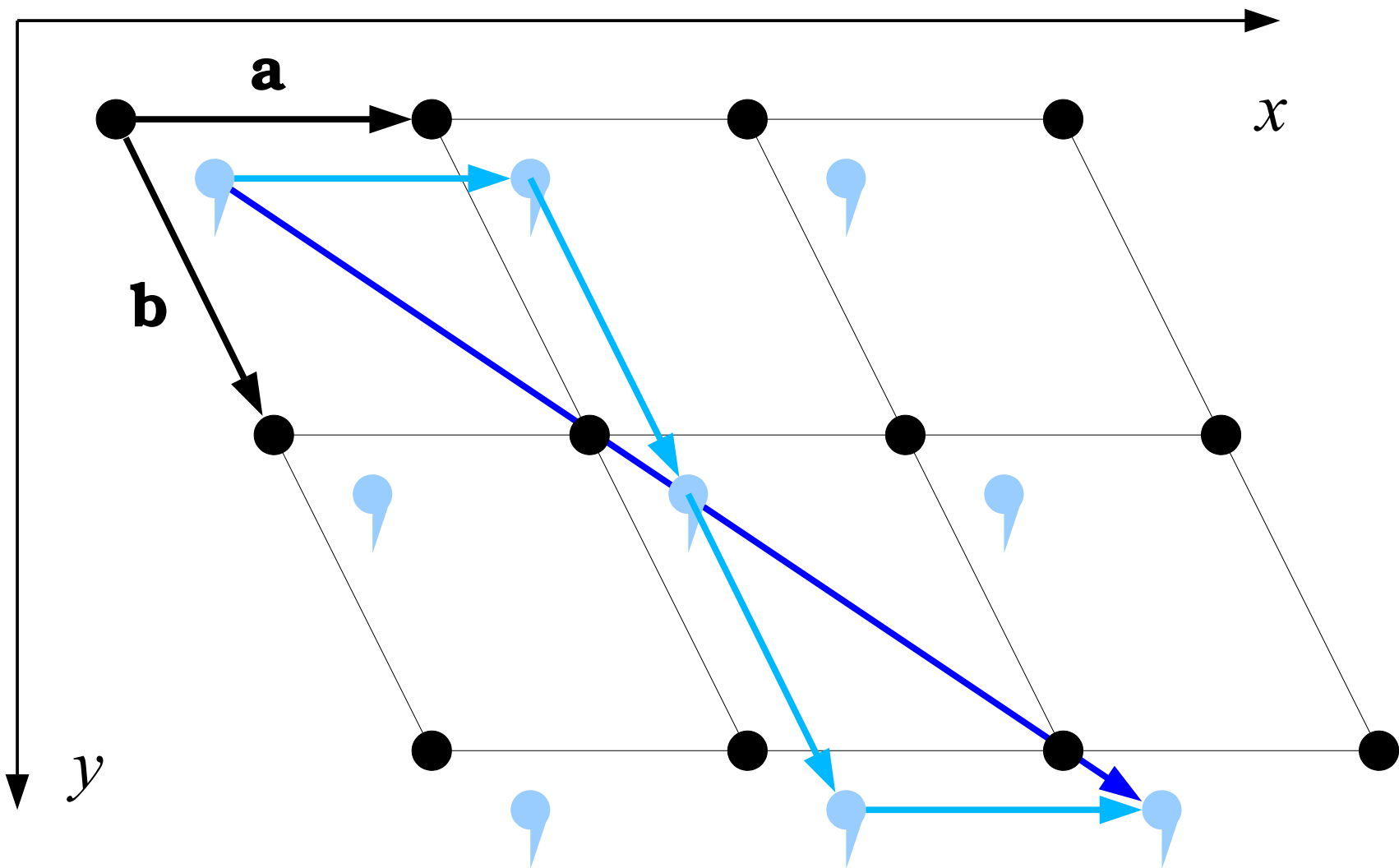

# Tipiškas difrakcijos vaizdas

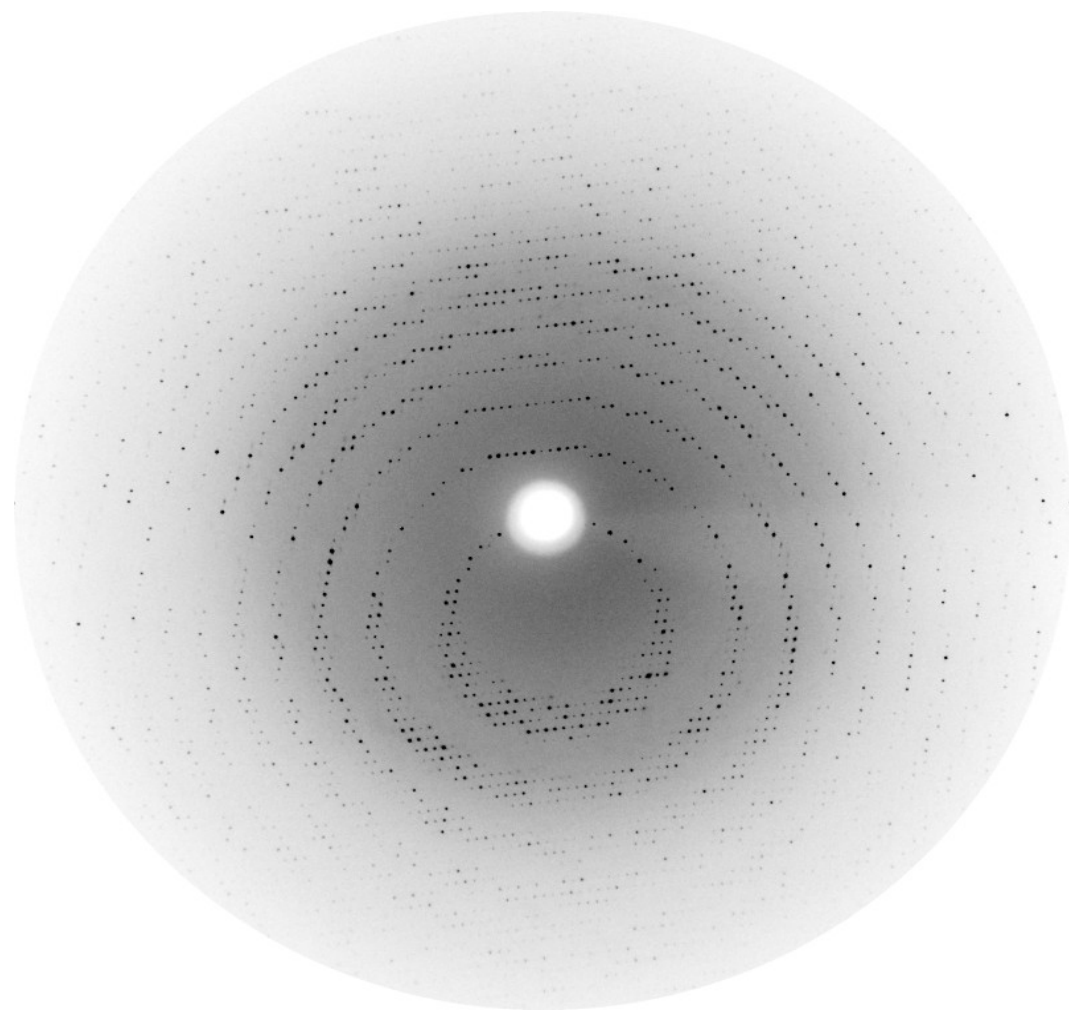
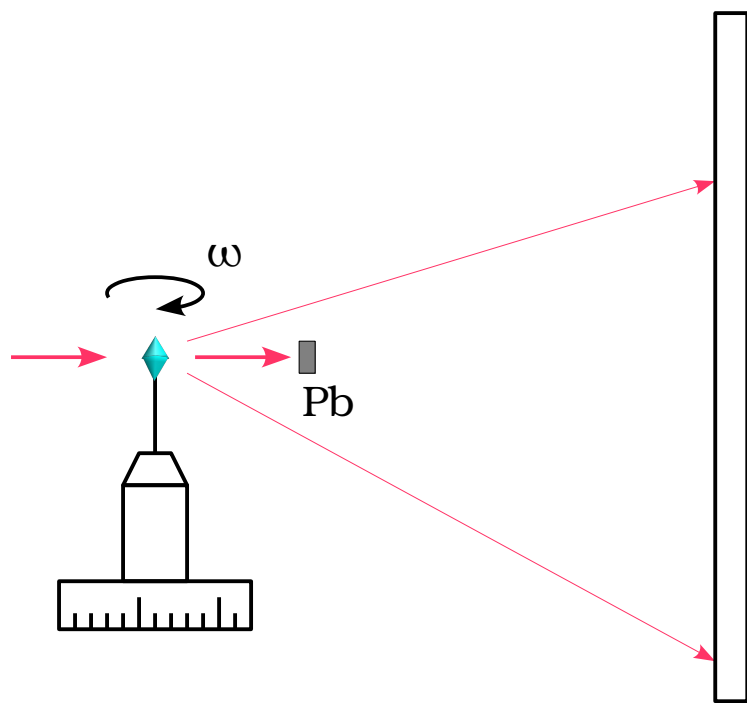

# Kristalų difrakcija





# Brego dèsnis

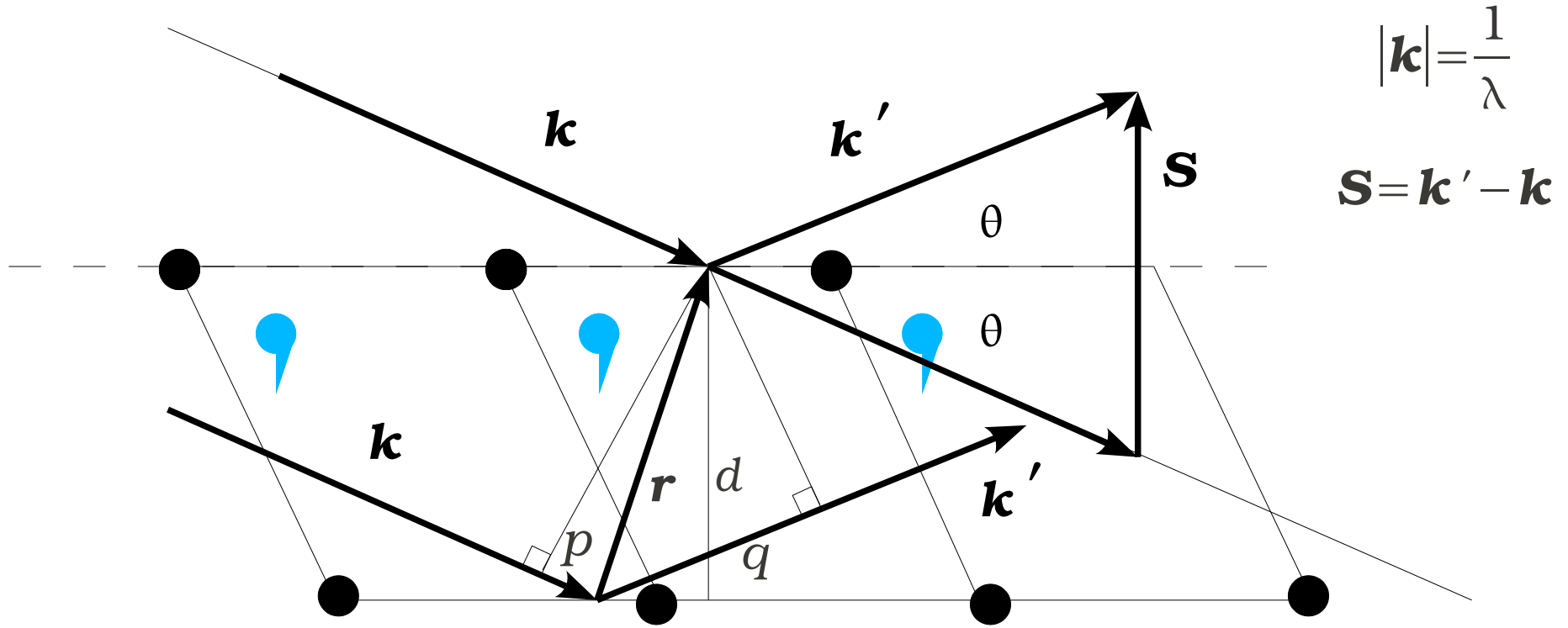

2) Brego dèsnis (Bragg's law):

$$\Delta = p + q \quad \Delta = (\mathbf{k}' - \mathbf{k}) \cdot \mathbf{r} = \mathbf{S} \cdot \mathbf{r} = \frac{\mathbf{S} \cdot \mathbf{r}}{|\mathbf{S}|} |\mathbf{S}| = d |\mathbf{S}| = \frac{d \cdot 2 \sin(\theta)}{\lambda} = n$$

$$p = -\hat{\mathbf{k}} \cdot \mathbf{r} / \lambda$$

$$q = \hat{\mathbf{k}}' \cdot \mathbf{r} / \lambda$$

$$|\mathbf{S}| = \frac{n}{d} = \frac{2 \sin \theta}{\lambda}$$

# Atspindys nuo kristalo

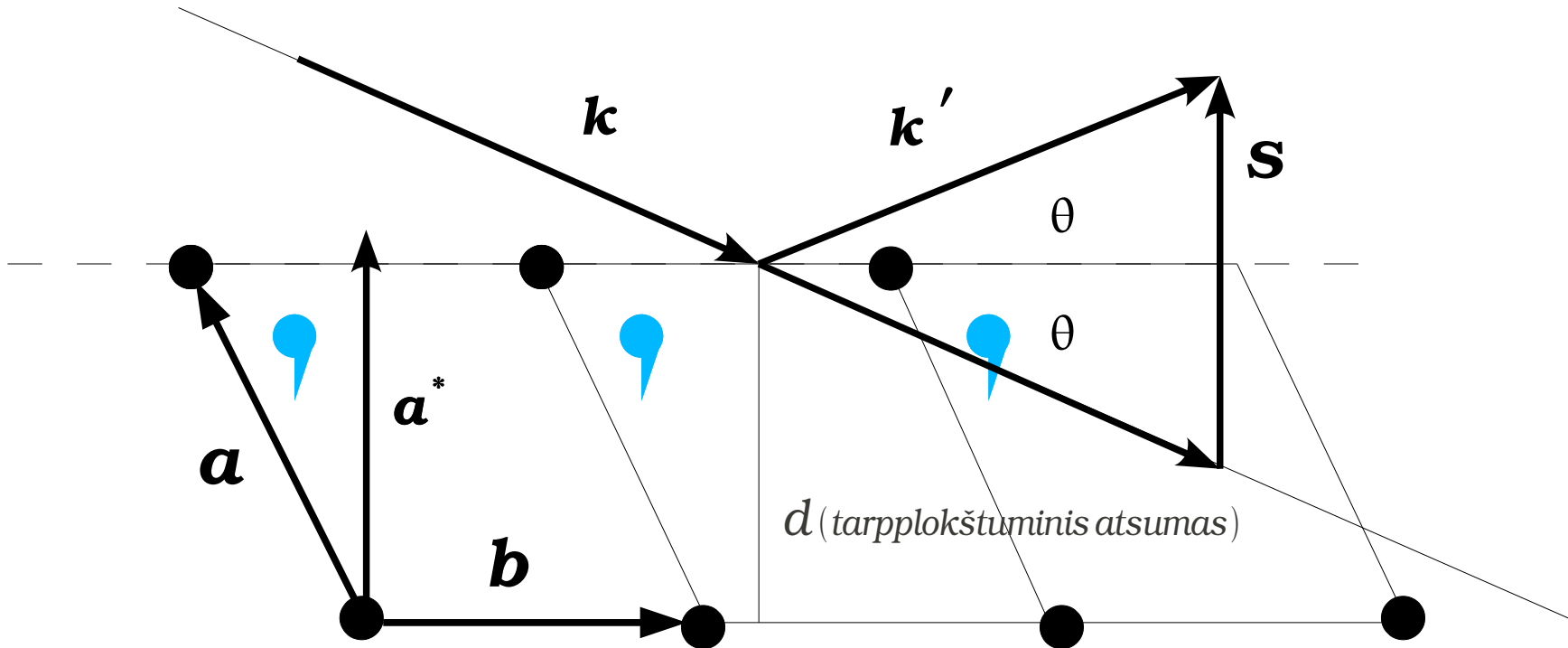

1) Laues (Laue) sąlygos:

$$\mathbf{S}\mathbf{a} = h; \quad \mathbf{S}\mathbf{b} = k; \quad \mathbf{S}\mathbf{c} = l$$

$$\mathbf{S} = h\mathbf{a}^* + k\mathbf{b}^* + l\mathbf{c}^*$$

2) Brego dėsnis (Bragg's law):

$$|\mathbf{S}| = \frac{n}{d} = \frac{2 \sin \theta}{\lambda}$$

$$\mathbf{S} = (\mathbf{k} - \mathbf{k}') / 2\pi$$

Spindulys atsispindi nuo kristalo tik tada, kai patenkintas Brego dėsnis ir Laues sąlygos.

# Elektronų tankis

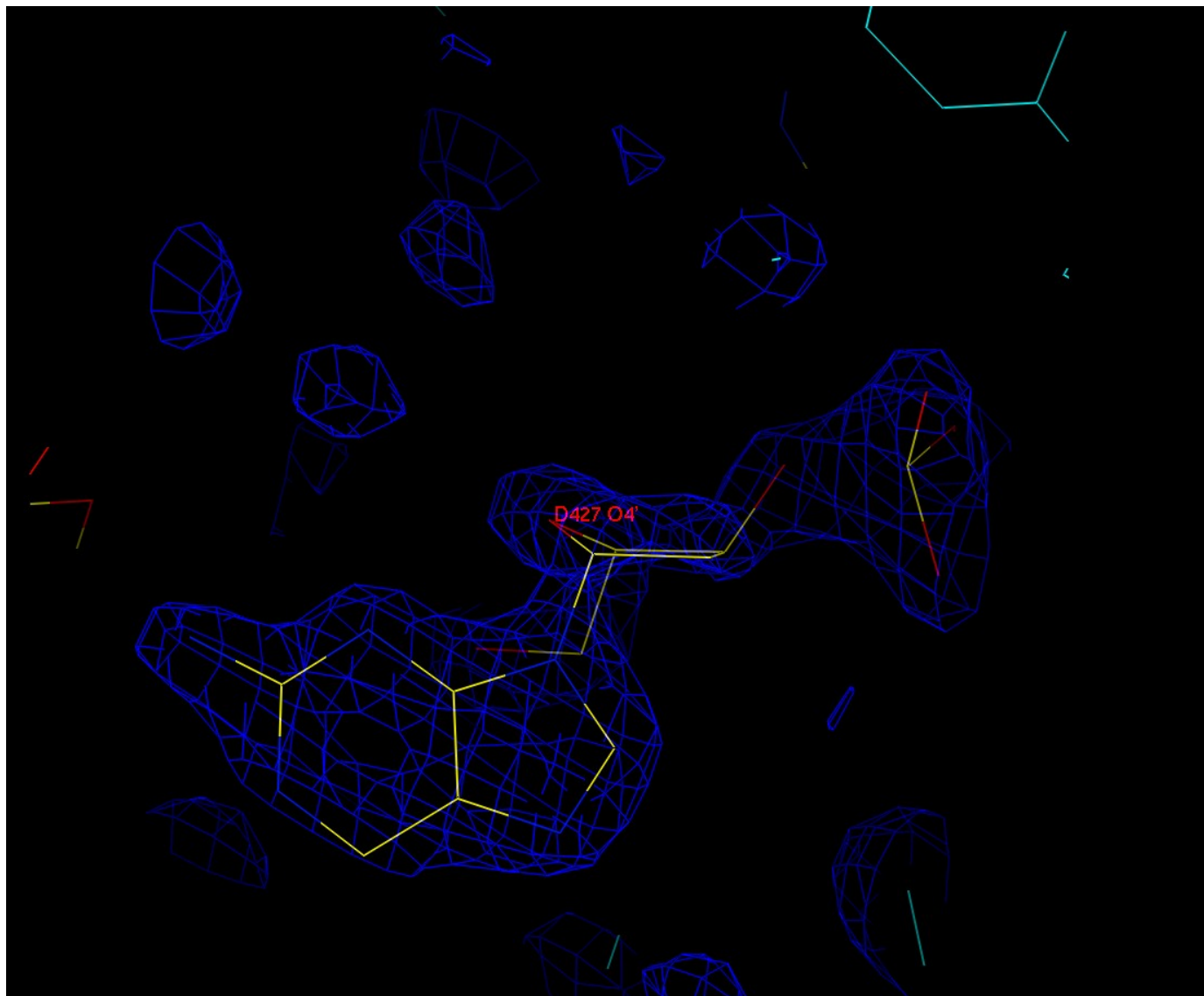

# Elektronų tankis (2)

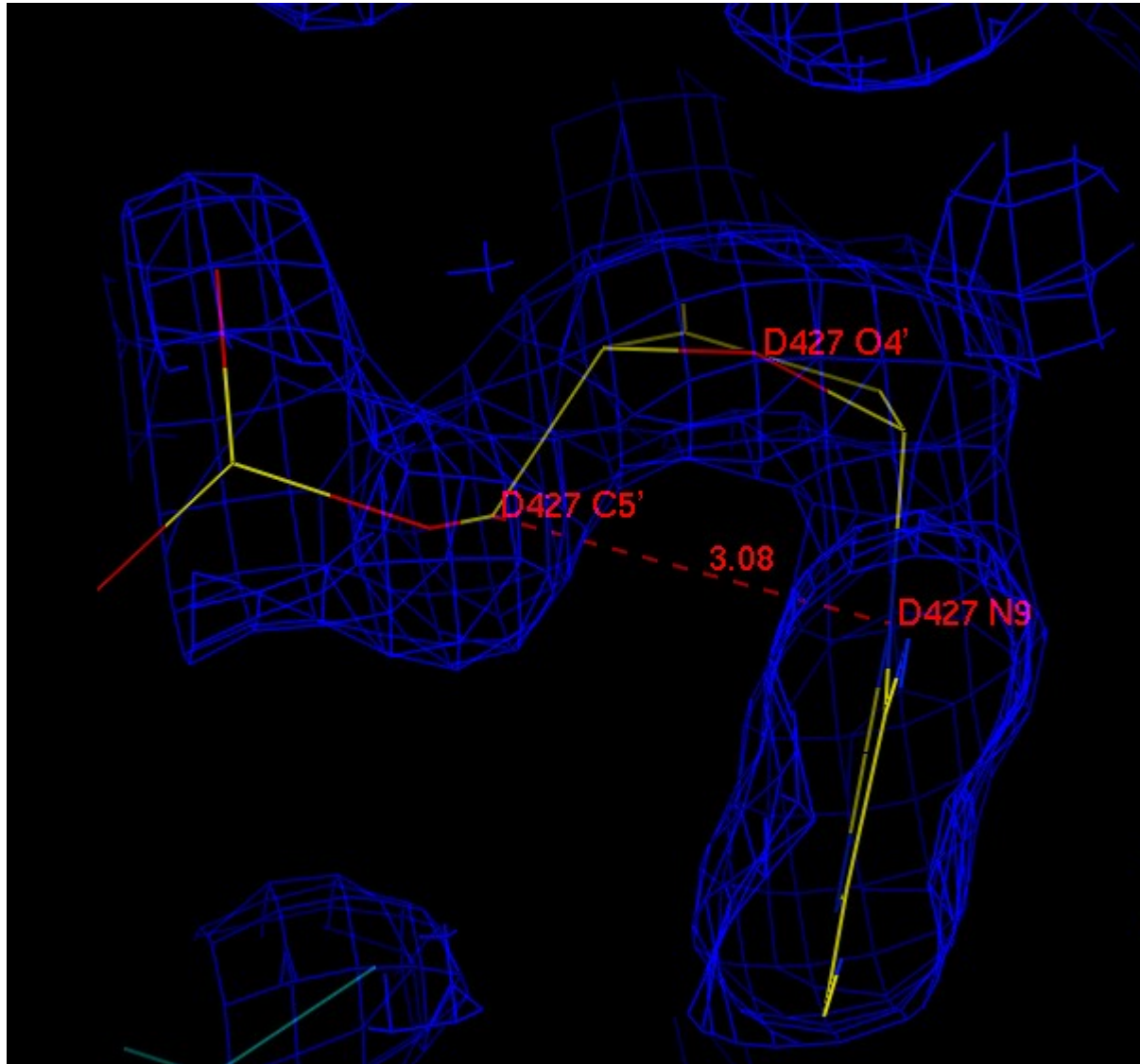

# Baltymų ir nuklorūgščių kompleksai

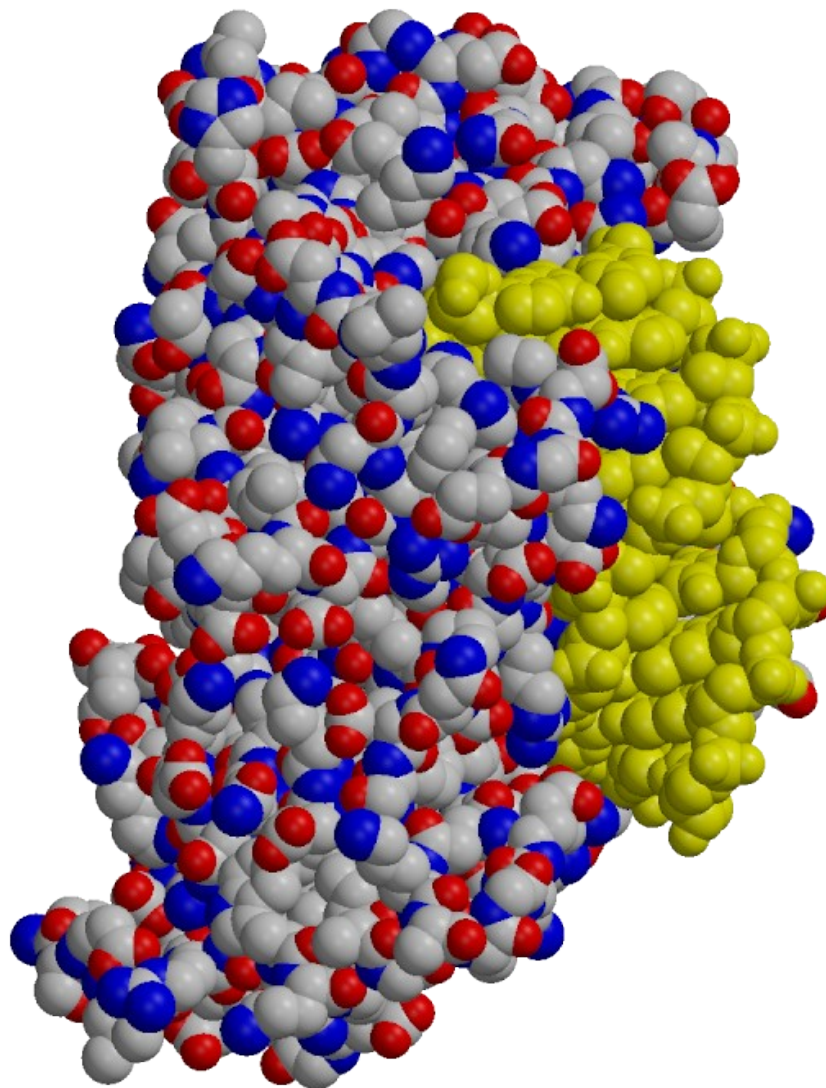

# Tretinē struktūra

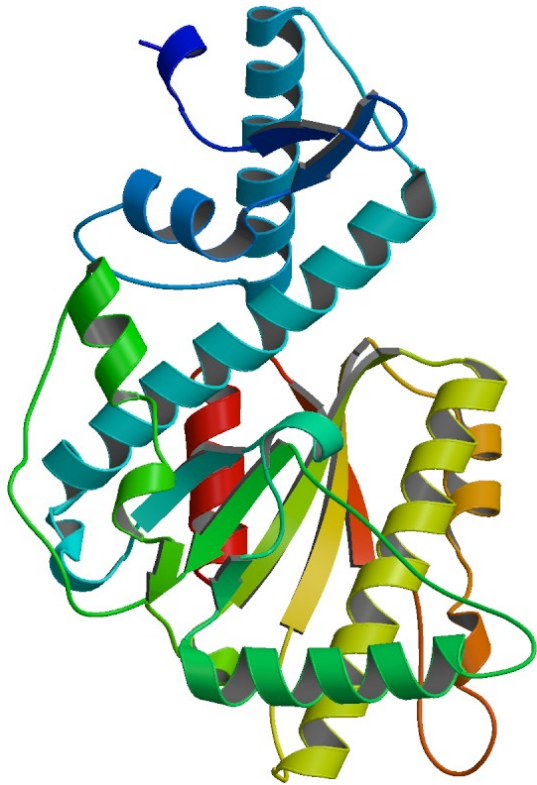

Bse634I restrikcijas endonukleazē  
Gražulis *et al.* NAR 2002 p.876

BfiI restrikcijas endonukleazē  
Gražulis *et al.* PNAS 2005 p.15797

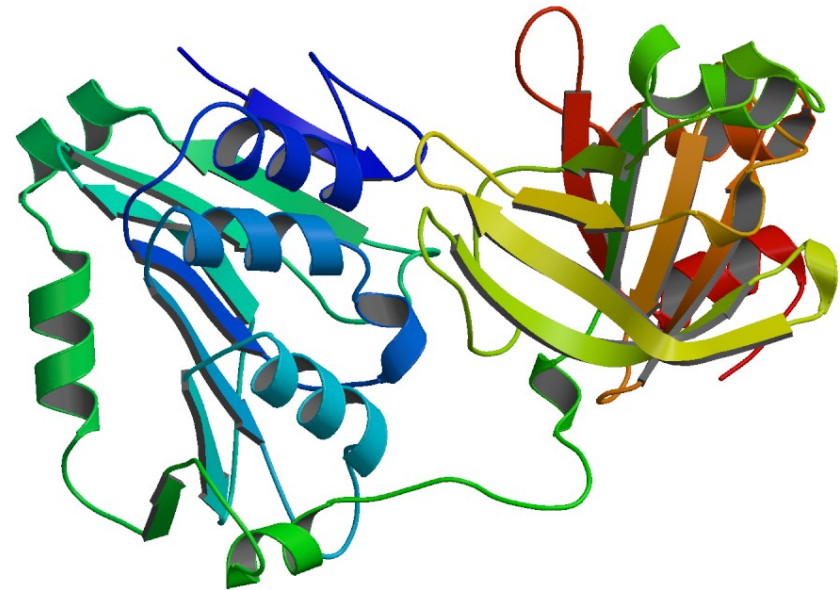



# Ketvirtinė struktūra

Bse634I REazės  
tetrameras kristale

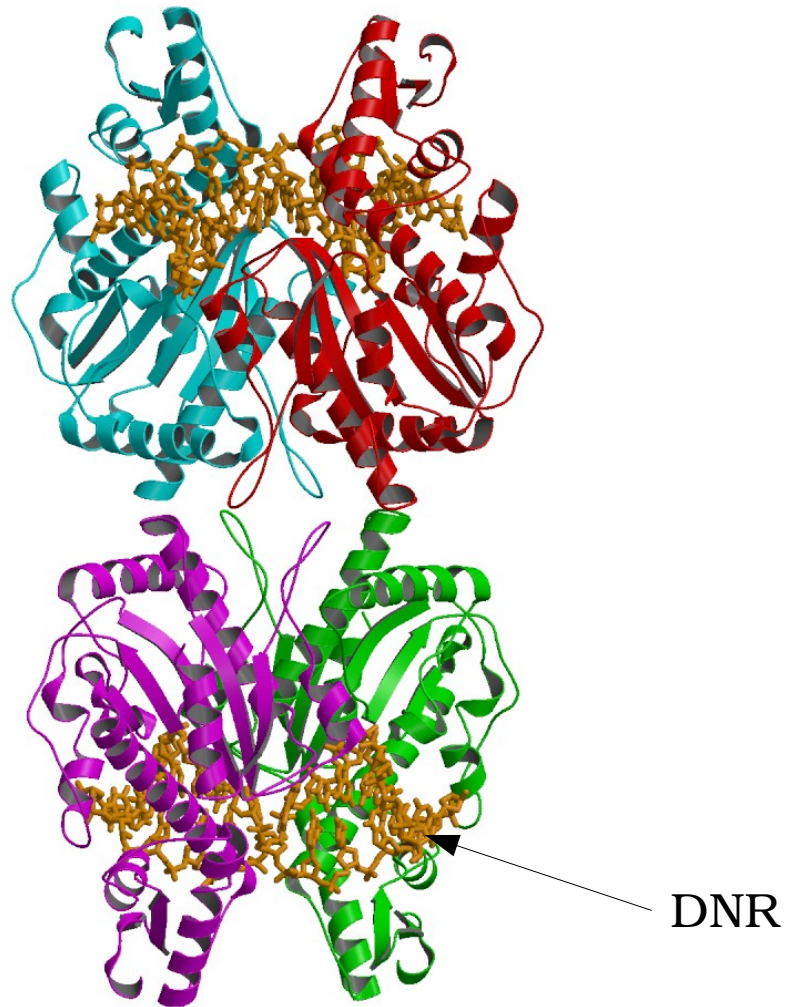

# Z formos DNR

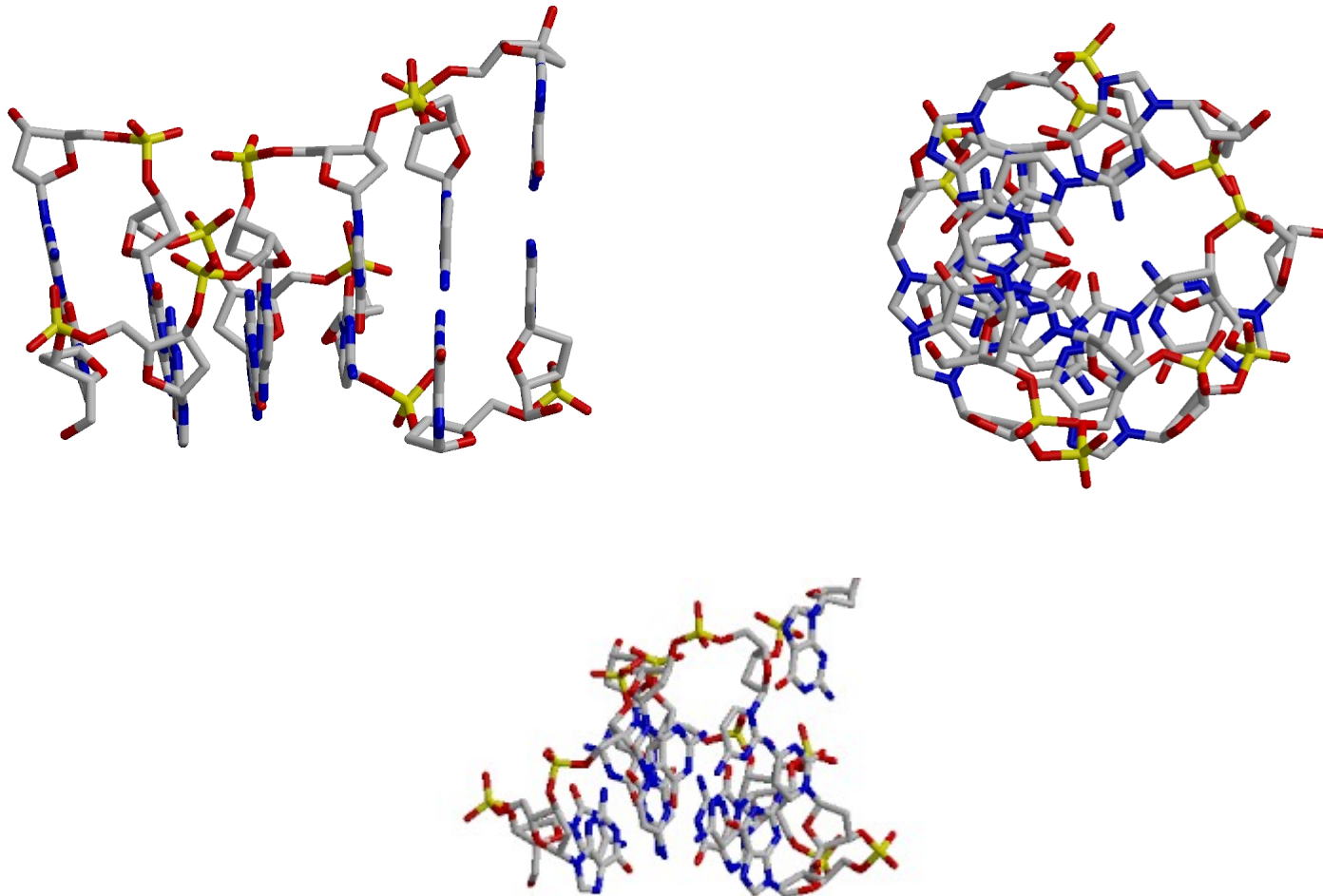

Andrew Wang, Alexander Rich, and co-workers in 1979 at MIT  
(šaltiniai: Vikipedija, Nukleorūgščių duomenų bazė (NDB))

# A ir B formos DNR

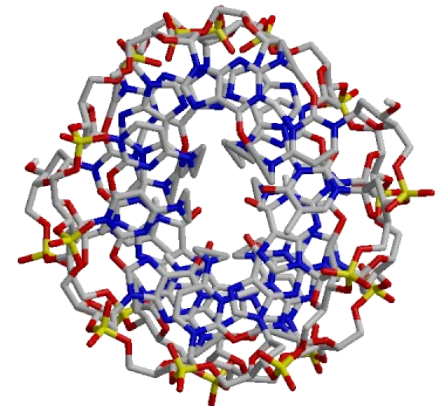
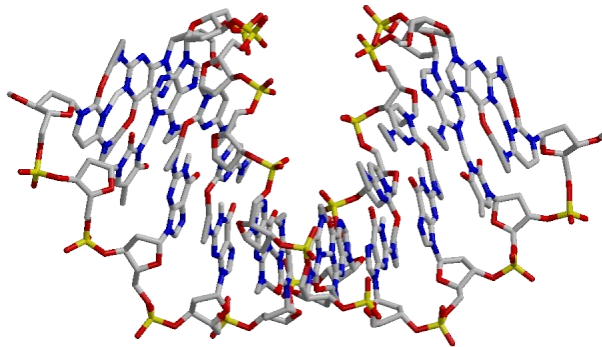
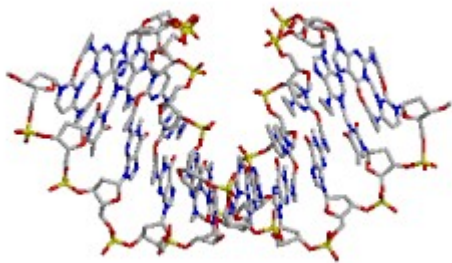
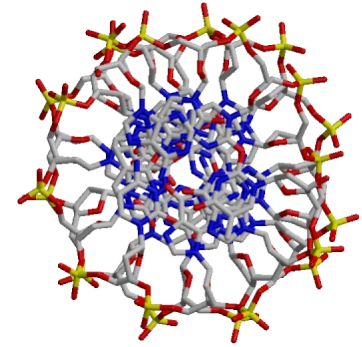
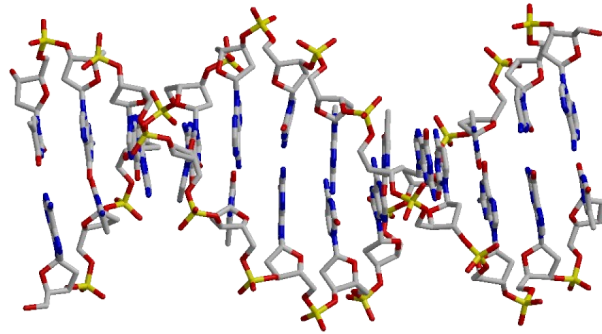
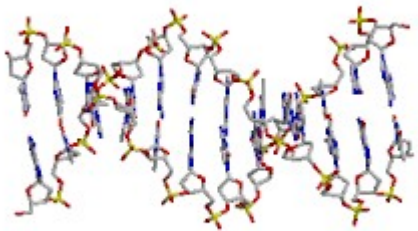

# Ribozimai

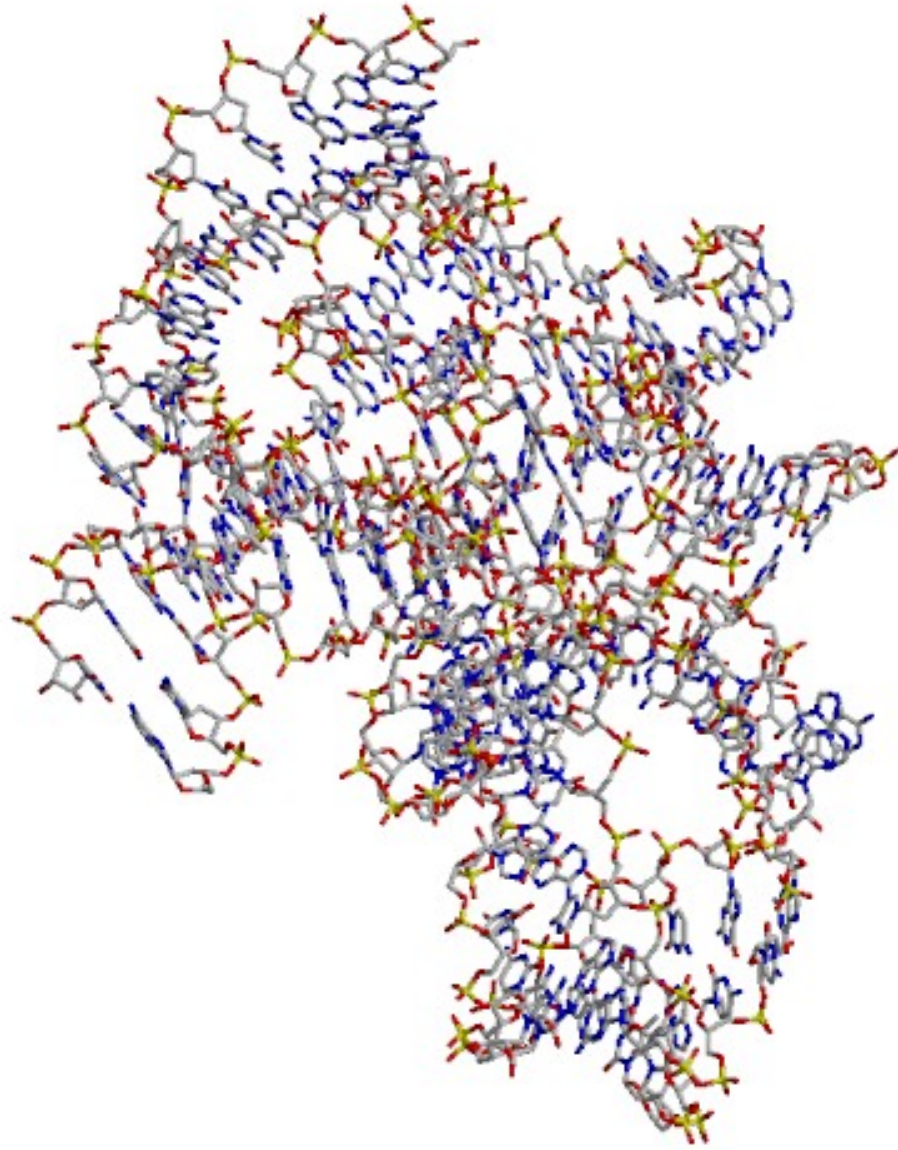



# Ribosoma



Ada Yonath

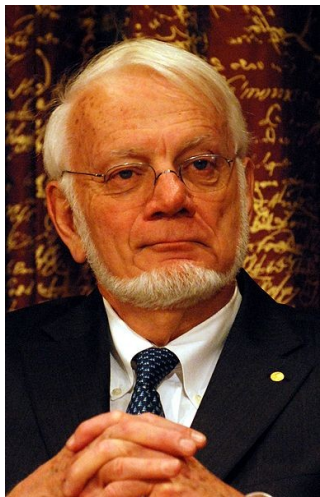

Thomas A. Steitz

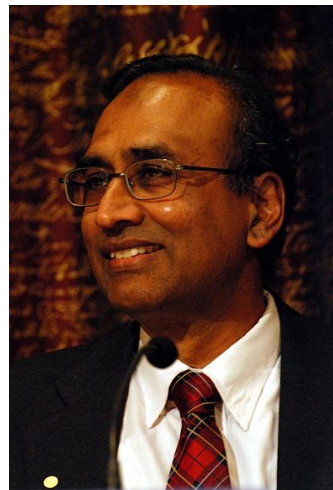

Venkatraman  
Ramakrishnan

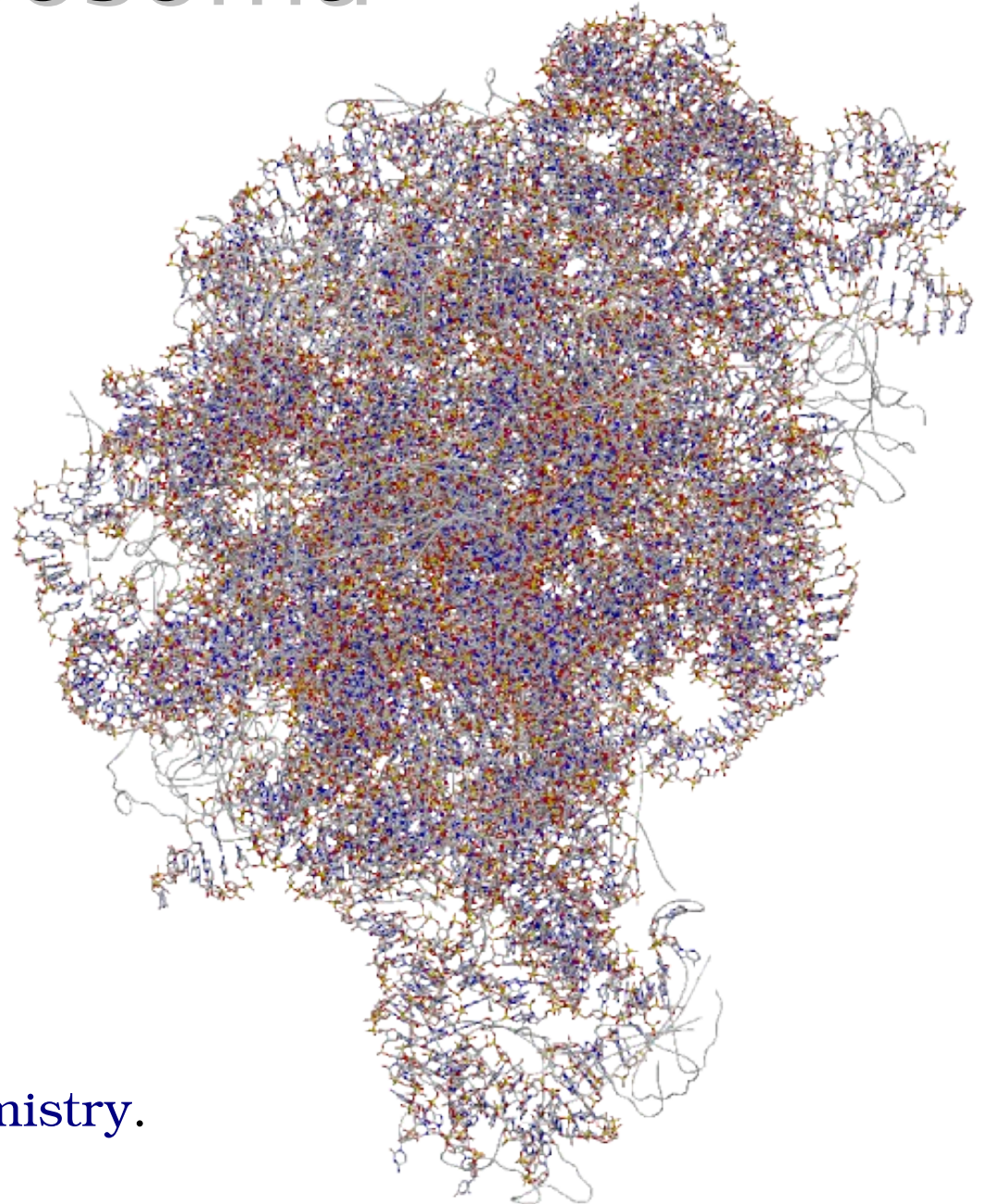

The **Nobel Prize in Chemistry**.  
2009

šaltiniai: Vikipedija, Baltymų duomenų bankas (PDB)

# Taikymai: racionali vaistų paieška

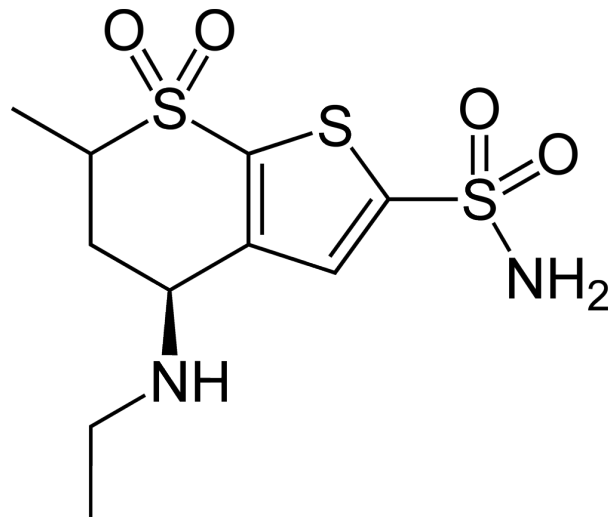

Dorzolaminas (karboninių anhidrazių inhibitorius, vaistas nuo glaukomos)

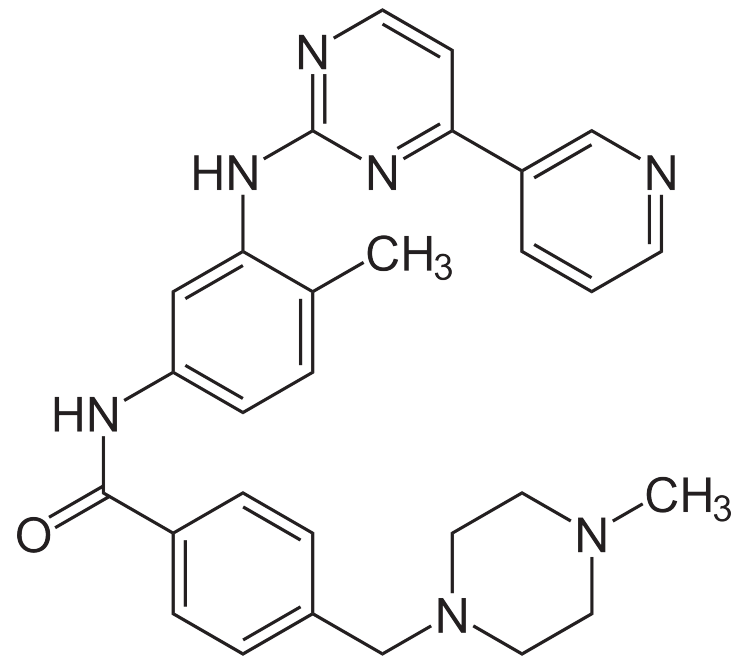

Imatinib'as (baltymų kinazių inhibitorius, priešvėžinis vaistas)



Ačiū už dėmesį  
Mielai atsakysiu į Jūsų klausimus

